

# Aluminium **Secondary Glazing**

For A Warmer, Quieter Life. Ideal For Use In Listed Buildings

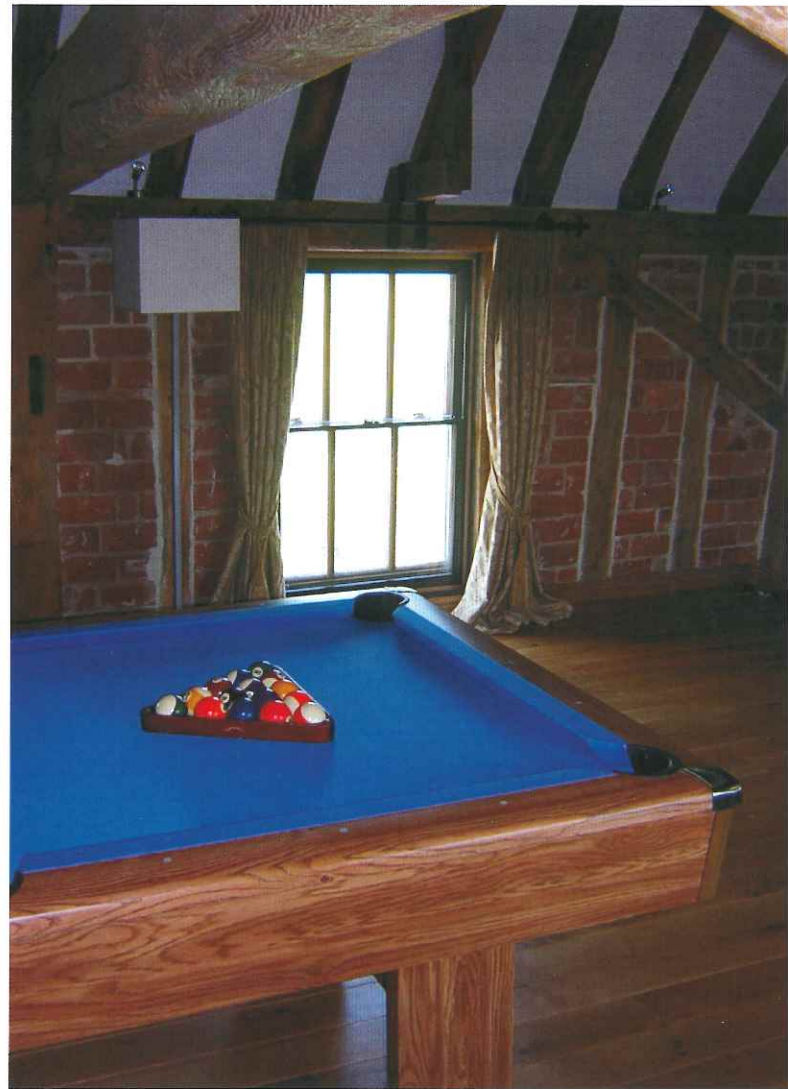

## What Is Secondary Glazing & Where Is It Used?

Secondary glazing involves adding an extra slim-line window in addition to your existing windows. Secondary glazing is designed to keep the heat in and the noise out. You could also save around 10% on your household bills by fitting our secondary glazing. Secondary Glazing is particularly suitable for use in listed buildings and conservation areas.

Secondary glazing is perfect for both residential or social housing on main roads - even where double glazed windows are already fitted. Any building where altering or replacing the prime window is not possible or not cost effective, such as listed buildings and rented accommodation, will benefit from the installation of secondary glazing. Our aluminium secondary glazing is of the highest quality, light weight, highly effective, with a range of specialist glass for maximum noise reduction and thermal performance. Built to last, it is virtually maintenance free and will give you many years of trouble free service. Come to the market leaders for all your secondary glazing needs, call us today.

### Benefits

- Improved thermal insulation.
- Save money on heating bills.
- Highly effective for noise reduction / insulation.
- Provide added security.
- Retain the exterior character of the building.

### Features

- White, silver, brown or any RAL colour available.
- Float, Obscure, Toughened, Laminated, 'K' and Acoustic glass options.
- Made to measure.
- Face fix (odd leg or subframe) or reveal fix (extended subframe) options.
- Ease of installation.
- Comes complete with trims to cover up fixing screws.
- Can incorporate flyscreens, for use in summer months.

### What does it look like?



They come in white, silver or brown or any of 200 RAL colours. Aluminium is strong and durable, which means the frames can be designed to be very slim without sacrificing strength, so that they blend into the existing window. They come with

covering trims so you don't see any of your fixing screws & the units can be pre-drilled for easier installation. We also manufacture curved and arched secondary glazing.



Noise Reduction



Heat Insulation



Flyscreens

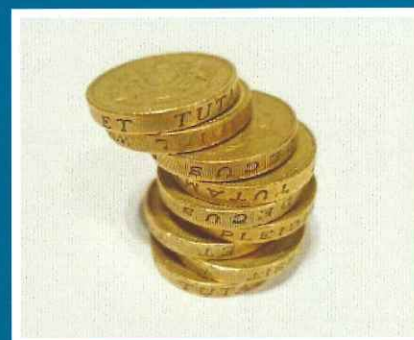

Save Money On Heating Bills



Listed Buildings

## Noise Reduction

Noise from traffic, aircraft and the general noise from inner city areas and main roads can be a real disruption to the quality of your living or working environment. Fitting secondary glazing is a cost effective way to significantly reduce external noise. 4mm glass is very effective at providing noise insulation, but by specifying high specification glass (6mm+) such as Laminated glass or Acoustic glass you can further improve on the amount of noise reduction.

## Thermal Insulation & Draft Reduction

Our secondary glazing can reduce heat loss in your windows by up to 50%. You can specify ordinary Float or Toughened glass, or for even better thermal performance you can specify Pilkington 'K' low e glass. By adding the extra pane of glass in addition to your existing windows heat loss is dramatically reduced. For extreme circumstances we have a heavy duty system that can take a double glazed unit for the ultimate in thermal insulation and noise reduction.

## Styles of Secondary Glazing

We offer an extensive secondary glazing range to cater to all of your needs. Designed to suit almost any building, historic or contemporary, and to be as sympathetic as possible to the character of the building.

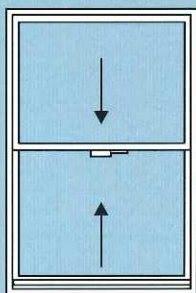

### Vertical Sliding

- Ideal for traditional sash windows.
- Optional spring balances available to support sliding sash in any position.
- Three different frame options.
- Optional tilt back facility.

### Horizontal Sliding

- Ideal for casement and ribbon windows.
- Smooth sliding action using nylon pads or roller wheels.
- Three different frame options.
- 3 track option for maximum ventilation.

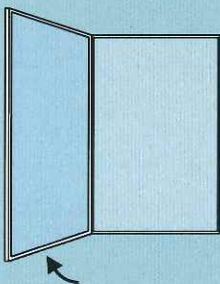
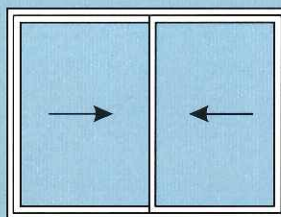

### Hinged Units

- Suitable for both windows and doors.
- Butt hinged or friction hinged.
- Two different frame options.
- Perfect for fire escapes and for maximum ventilation.

### Lift Out & Fixed Units

- Suitable for applications where access to the existing windows isn't paramount.
- Perfect for specialist applications (i.e bays).
- Fixed system is especially cost effective.
- Can easily be curved.

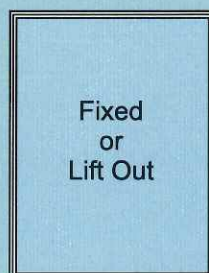

Horizontal Slider



Triple Track Horizontal Slider



Vertical Slider



Tilt Back Vertical Slider



Suitable For Commercial Or Residential Buildings

# SECONDARY GLAZING SURVEY KIT CONTENTS

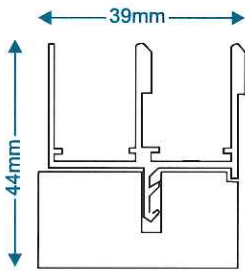

Horizontal / Vertical Sliders  
SF1 Face Fix Subframe

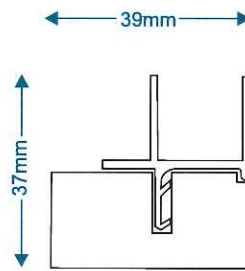

Lift Out  
SF1 Face Fix Subframe

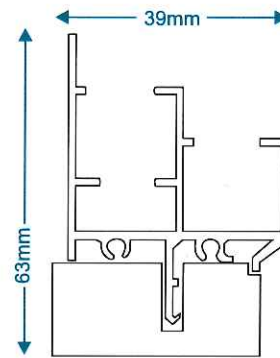

Vertical Sliding Tilt Back  
SF1 Face Fix Subframe

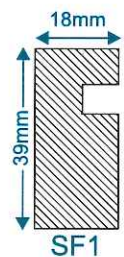

SF1

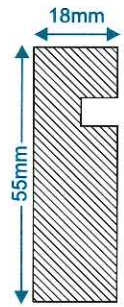

SF3

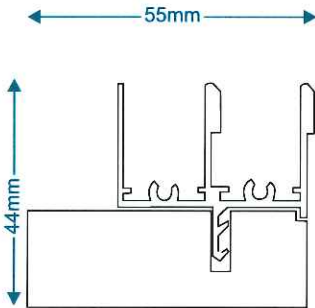

Horizontal / Vertical Sliders  
SF3 Reveal Fix Subframe

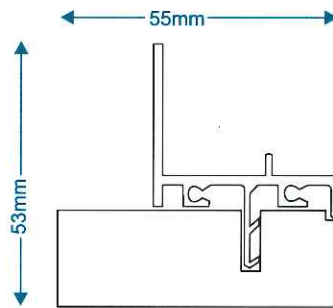

Hinged (Butt and Friction)  
SF3 Reveal Fix Subframe

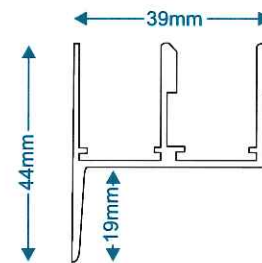

Horizontal / Vertical Sliders  
Economy Odd Leg Fix

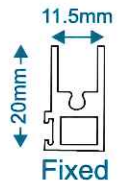

Fixed

## TRIMS

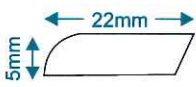

TM1

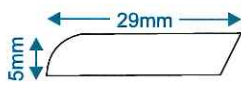

TM2

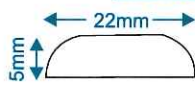

TM3

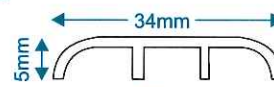

TM4

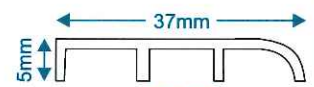

TM5