

# Durafold 1000 Slimline

Aluminium Bi-Folding Doors



**Relax**  
**& Enjoy**  
*Your New*

# **Durafold 1000 Slimline** Bi-folding Door



Our Durafold 1000 Slimline Bi-folding doors are designed to change the way you live and relax by transforming your home environment into a private oasis. Whether you enjoy quiet summer evenings with family or a night of entertaining with friends, these doors offer great versatility of use and can be designed to suit your project and the way you want to live.

The slim aluminium lines offer the perfect focal point to any room enabling you to bring the outdoors in and make the most of your beautiful garden or stunning views. The extensive range of colours and hardware also means each door can be fully customised to suit your individual style requirements and provide that perfect look you wanted.

The Durafold 1000 Slimline Bi-folding doors comes with the assurances you would expect from a quality designed product that requires minimal maintenance and delivers reliable performance over a lifetimes use. Just relax and enjoy your newly created space and doors.

## Key Features

- Quick Glaze Bead for rapid stress free installation.
- Slimmer profiles give greater glass area.
- Uses low maintenance, hard wearing powder coated aluminium.
- Over 200 single or dual colours.
- Single or French door styles to match.
- Exceptional array of security features as standard.
- Doors are bottom hung and run on double stainless steel tracks.
- An assortment of glazing options offered including laminated security and solar control glass.
- Options for dust free integrated blinds.
- All door styles have the option to open in or out.
- U-values as low as 1.5 W/M<sup>2</sup>K.
- Internally beaded for added security.

## Options

- 2 to 7 panel folding configurations. (8+ panels please ask)
- Low or rebated thresholds.
- Square bead to the interior.
- Square profile to the exterior.
- Black gaskets.
- Range of quality hardware in a variety of colours.
- Colour matched aluminium quad trims



# Door Styles

1 & 2 Panels

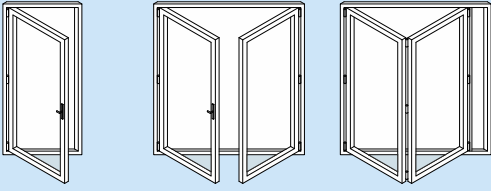

3 Panels

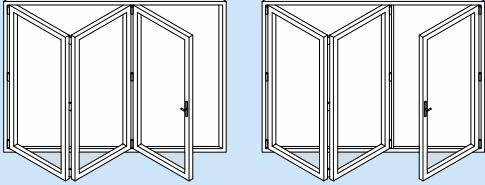

4 Panels

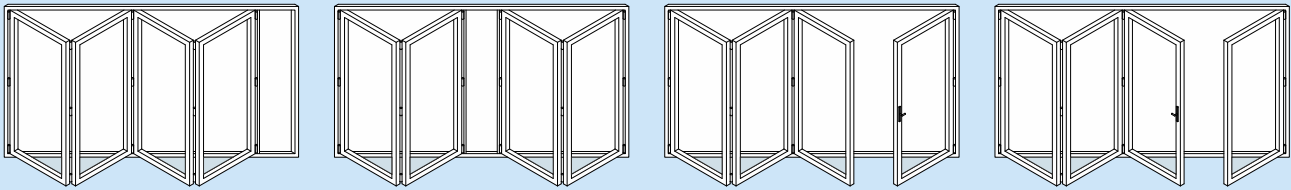

5 Panels

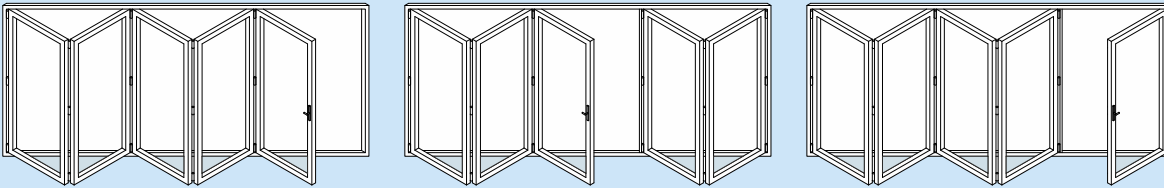

6 Panels

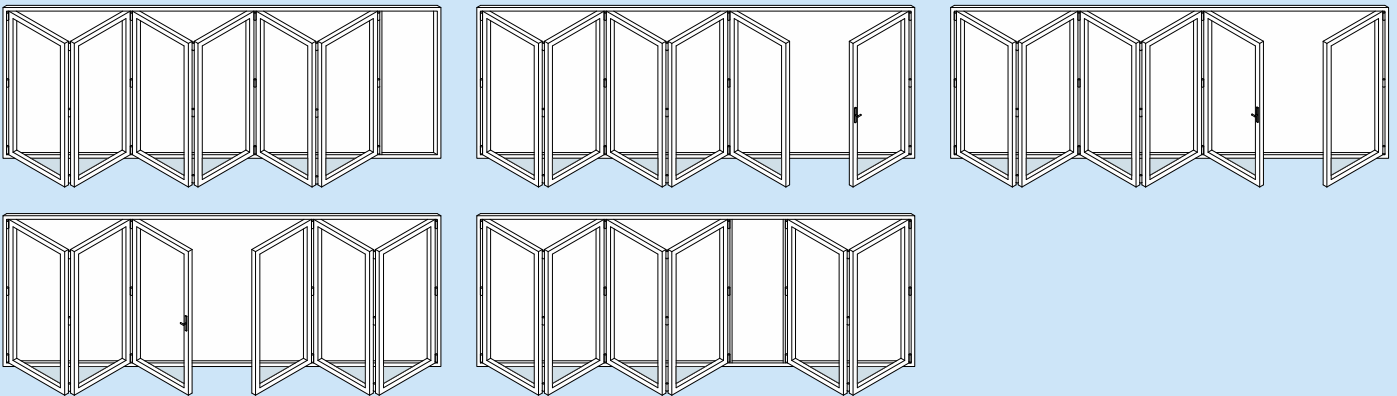

7 Panels

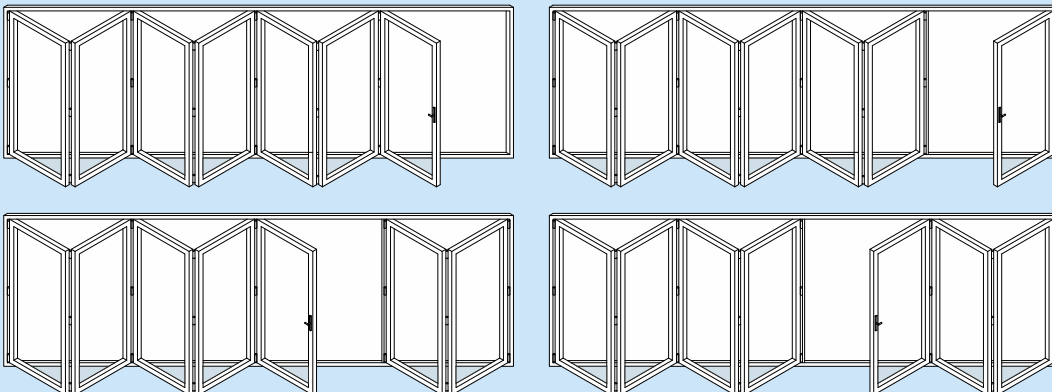

Panel Widths		Door Heights	
Minimum Width	700	Minimum Height	1600
Maximum Width	1200	Maximum Height	2500

- All bi-folding door styles can be mirrored from shown.
- All styles have a choice to either open out or open in.
- The sizes detailed above are for guidance only.
- If the sizes you require are less than the minimum or exceed our maximum recommended sizes please contact us.





# Security

Our Durafold1000 Slimline bi-folding doors are equipped with a comprehensive set of security features designed to give you peace of mind that your property is safe and secure.

- All handles are key lockable as standard.
- Lever handles use a 6 point locking system. This includes 2 heavy duty hook locks, 1 dead bolt, 1 latch and 2 roller cams.
- Intermediate panels use heavy duty shoot bolts top and bottom.
- Bogie wheels and top rail guide are used as an anti-jemmy feature to prevent panels being lifted off the tracks.
- On doors with outside access we use high security cylinders that are pick resistant, anti-drill and anti-bump.
- Upgrade to laminated glass for added security.
- The doors are internally glazed to offer greater security.

# Performance

Our doors are designed to provide the best performance possible. With the longevity of aluminium and minimal maintenance needed these doors are designed to last the test of time.

WER	U-Value W/M <sup>2</sup> K	Air Permeability	Water Tightness	Wind Resistance
				
Rated C	Up to 1.5	600 Pa	750 Pa	1800 Pa
1.2 Softcoat				

# Threshold Options

- 52mm Standard rebated threshold.
- 52mm Standard rebated threshold with integrated cill.
- 20mm or 15mm Flush threshold with optional clip in ramps.
- Cills come in 4 projections of 85mm, 150mm, 190mm or 225mm (all cills are 25mm in height).
- Flush thresholds can be sunk into the floor.
- Standard rebated thresholds can be sunk into the floor to create minimal step over and give maximum weather performance.

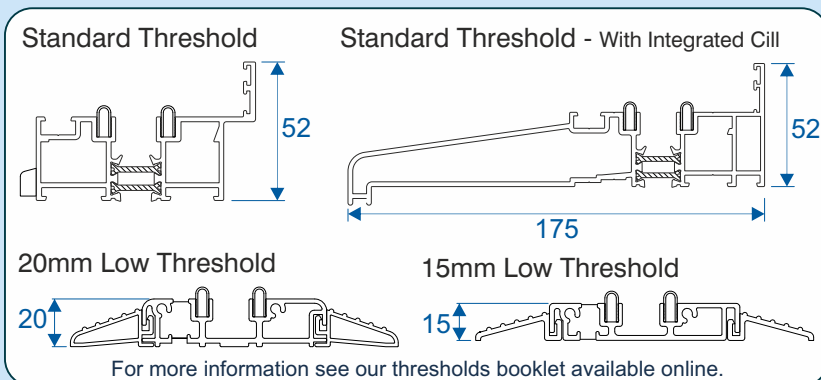

Anti-Bump Cylinder

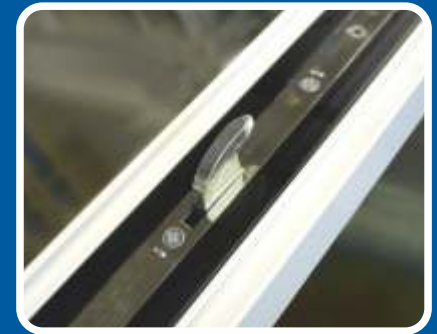

Heavy Duty Hook Lock



Thermally Efficient



Standard Threshold With Cill

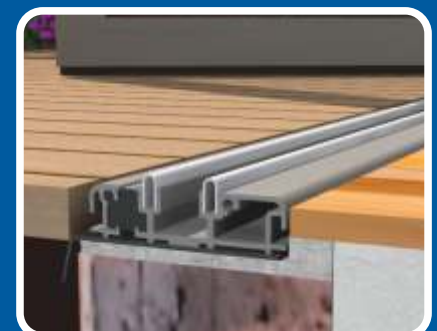

20mm Flush Threshold

# Colours

Our Durafold1000 Slimline bi-folding doors are available in a vast range of colours, some of which are shown below:

## DUR Colours - Flat Paint Finish

Std White  
(9010 G)



White  
(9010 M)



Black  
(9005 M)



Dark Grey  
(7016 M)



Medium Grey  
(9007 Met.)



Silver Grey  
(9006 Met.)



Light Brown  
(8014 M)



Dark Brown  
(8019 G)



Cream  
(1015 M)



Blue  
(5011 M)



Red  
(3004 M)

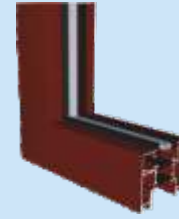

Green  
(6009 M)



## Trend Colours - Textured Paint Finish

Anthracite Grey  
(DUR 14 ST)



Frost White  
(DUR 022 T)



Velour White  
(DUR 001 T)



Silver Grey  
(DUR 017 T)



Platinum Grey  
(DUR 016 T)



Diamond Grey  
(DUR 026 T)



Obsidian Black  
(DUR 013 T)



Vulcan Black  
(DUR 014 T)



Sand  
(DUR 003 T)



Chestnut Brown  
(DUR 024 T)



Sky Blue  
(DUR 009 T)



Olive Green  
(DUR 018 T)

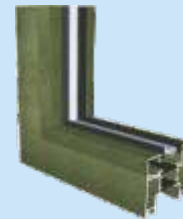

## RAL Colours

200+ RAL Colours



This is only a selection of the available colours. Visit our website for more options.  
Please note that for technical reasons associated with colour reproduction the images only give an indication of shade.  
No guarantee can be given that they will exactly match the powder coated product.

# Glass Options

Toughened - Safety



Planitherm ONE - Thermal



Laminated - Security



Self Cleaning Only



Solar Control Only



Solar Control & Self Cleaning



Manual Block Blind



Remote Control Blinds



Vulcan Black Out / Matt White In



Standard White KL 9010 Gloss



Light Brown - KL 8014 Matt



Dark Grey - KL 7016 Matt

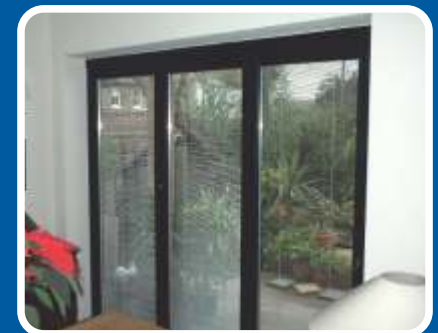

Integrated Blinds

\* Our doors are also available un-glazed.

# Hardware

## Traffic Door Handles



## Intermediate Panel Handles (Single Colour White or Anthracite Grey)



## Intermediate Panel Handles (All other Coloured Doors)



## Buffer Magnets



## Optional D-Handle



All handles are also available in gold chrome and RAL matched colour. Please note some hardware may change in design as shown depending on colour availability.



# Technical

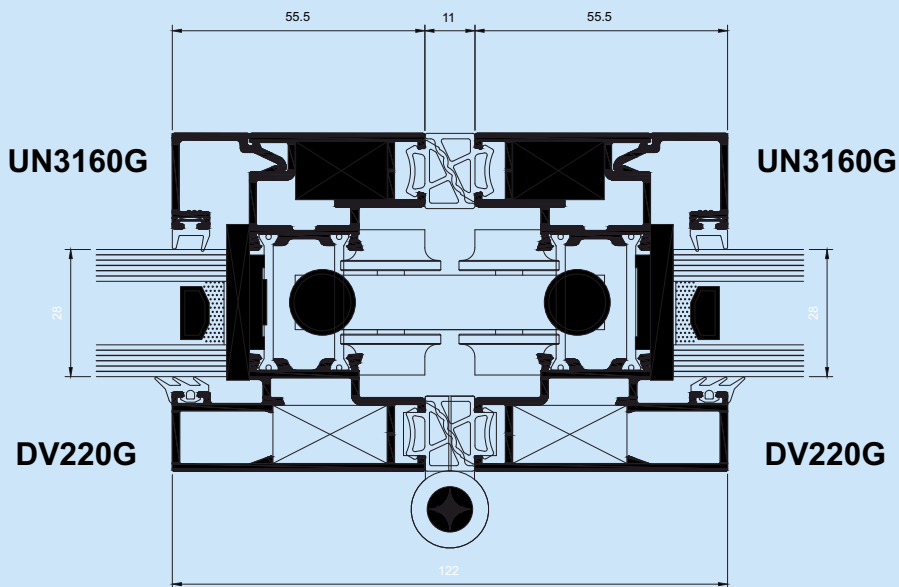

All sizes in mm



Thermally Broken Aluminium



Large Clear Openings



Heavy Duty Bogie Wheels



Optional Aluminium Quad Trim

# Threshold Options

Our Durafold1000 Slimline bi-folding doors are available with three different threshold options as shown below. The below images are examples of how the thresholds can be used when installed (open out shown).

## Standard Threshold



## Standard Threshold With Cill



## 15mm Low Threshold



## 20mm Low Threshold



# Why Aluminium?

There are many reasons why aluminium is a better material when making bi-folding doors compared to other materials.

Aluminium as a material can be customised in a wide range of colours and special textured finishes as well as gloss, semi gloss or matt finishes.

Due to aluminium being a metal it offers great strength as a material which means we can create slimmer sight lines while maximizing glass area. This is not possible with a lot of other materials as they cannot support the load of large glass units.

The life span of an aluminium product is measured in decades rather than years.

Aluminium is a sustainable building material and is recyclable. The recycling process creates high quality aluminium which loses none of the physical properties, meaning that it can be endlessly recycled for use as new products without losing quality. Recycled Aluminium also uses just 5% of the energy it takes to create primary aluminium.

## Safety

Our bi-folding doors have been designed with safety in mind. We know what safety means to our customers which is why we spend time to make our door safer to use.

Our doors are all fitted as standard with finger safe gaskets to help maximise safety when little fingers use the doors.

All our traffic doors are fitted with buffer magnets which join the traffic door to the next panel. This feature prevents the door from slamming shut or moving around in the wind.

## Low Maintenance

We only use the finest quality materials and hardware for our doors. This is why there is very little work (if any) involved when it comes to maintaining them.

Aluminium is a great material for minimising your time spent on keeping it looking fresh and new. Unlike other materials aluminium will not rot, rust or need to be repainted. All your new aluminium bi-folding door will need is the occasional wash down with warm soapy water.

We use high grade polyester powder coatings from only approved sources to paint our metal. This coating has a high resistance to marking and colour fading meaning your doors will maintain that new feeling for longer.

Our quality stainless steel tracks and wheels provide long term ease of operation and require minimal maintenance.

- Light Weight With High Strength
- Durable
- High Resistance to Corrosion
- Low Maintenance
- Longer Life Span
- Recyclable & Sustainable
- Extensive Colours and Finishes
- Slim Sight Lines
- Maximum Glass Area



